

Voyager Portable

Instructions for Use

IMPORTANT: Read these instructions before installing, operating or servicing this product.



CE

**DO NOT DESTROY
KEEP ENCLOSED KEY AND MANUAL
WITH THE LIFT AT ALL TIMES.**

Joerns

Design Policy and Copyright

® and ™ are trademarks belonging to the ArjoHuntleigh group of companies.

© ArjoHuntleigh 2014.

As our policy is one of continuous improvement, we reserve the right to modify designs without prior notice.

The content of this publication may not be copied either whole or in part without the consent of ArjoHuntleigh.

Table of Contents

General Information	4
Foreword	4
Suitability	4
Service and Support	4
Manufacturer Information.....	5
Distributor Information	5
Definitions Used in this Manual	5
Intended Use	5
Operational Life	5
Product Identification	5
How to Use this Manual.....	5
Symbols Used.....	6
Safety Instructions	7
General Instructions	7
Safe Working Load	7
Important Safety Directions	8
Shock Prevention.....	8
Fire and Explosion Prevention.....	8
Human and Environmental Safety Practices	9
Battery and Battery Charger Safety Practices	9
Homecare Environment Considerations	9
Parts Designation	10
<i>Voyager Portable</i> Lift and Charging Station	10
Hand Control	11
How to Use the Voyager Portable	12
Before Approaching the Patient.....	12
Transferring the Patient	13
Emergency Lowering	14
Emergency Brake	14
Battery Information	14
Charging the Battery	15
Care and Maintenance	16
Preventive Maintenance Schedule	16
User Inspections.....	16
Inspections by an Authorized Service Technician	17
Cleaning the Lift.....	18
Daily Checklist.....	19
Strap Inspection.....	19
Handling and Storage	19
Battery Replacement	19
Verification of the Charger's Power Source	20
Sling Inspection and Care	20
Annual Inspection	20
UK Regulation.....	20
Troubleshooting	21
Labels on the Lift	23
Technical Specifications	24
Lift Dimensions	25
Electromagnetic Compatibility	26
Electromagnetic Compliance	26
Electromagnetic Emissions.....	26
Electromagnetic Immunity	27

General Information

Thank you for choosing the *Voyager Portable* lift from Joerns Healthcare.

Your *Voyager Portable* is part of a series of quality products designed specially for home care, nursing homes and other health care uses.

We are dedicated to serving your needs and providing the best products available along with training that will bring your staff maximum benefit from every Joerns Healthcare product.

Please read this manual thoroughly. Contact us if you have any questions about the operation or maintenance of your Joerns Healthcare product.

Foreword

Please read this manual in its entirety. It contains crucial information for the proper use and maintenance of the *Voyager Portable*. It will help protect your product as well as ensure that it performs to your satisfaction.

Lifting and transferring a person always present a potential risk. Informations in this manual are safety related and must be read and understood to help prevent injuries.

WARNING: Injuries can be attributed to the use of inadequate parts. Use only parts designated by Joerns Healthcare on your *Voyager Portable*.

WARNING: Unauthorized changes on any Joerns Healthcare product may affect its safety. Joerns Healthcare will not be held responsible for any accidents, incidents or deficiencies of performance that occur as a result of any unauthorized changes to its products.

Tested as per standards by: 

Suitability

The *Voyager Portable* range of lifts are suitable for the following categories of lift within the working parameters of the lifts specified in the technical specifications:-

Category A - Wheelchair

Category B - Bed

Category C - Bath

Category D - Toilet/ shower chair

Category E - Floor

Category F - 90 degree rotation

The *Voyager Portable* series are suitable for patients in the sitting, sitting/recumbent and recumbent positions.

Service and Support

A service routine must be done on your *Voyager Portable* by Joerns Healthcare trained service staff. This will ensure the product remains safe and functional. See "Care and Maintenance" section.

Please contact your local Joerns Healthcare agent for any of the following:

- more information,
- report an unexpected event or lack of performance,
- help in setting up, using or maintaining your *Voyager Portable*,
- replacement parts.

The agent can offer support and service programs to maximize the long-term safety, reliability and value of the product.

General Information

Additional copies of this manual can be purchased from your local Joerns Healthcare agent. When ordering, include the *Instructions for Use* product number (001.08075.04 rev. 11).

Manufacturer Information

This product has been manufactured by:
ArjoHuntleigh AB
Hans Michelsensgatan 10
211 20 Malmö,
SWEDEN

☎ : +46 (0) 10-335 45 00
☎ : +46 (0) 413-138 76
🌐 : www.ArjoHuntleigh.com

Distributor Information

UK Information

Joerns Healthcare Ltd,
Drakes Broughton Business Park,
Worcester Road,
Drakes Broughton, Pershore,
Worcestershire, WR10 2AG
United Kingdom

Customer Care ☎ : +44(0)844 811 1158
✉ : Info@joerns.co.uk
🌐 : www.joerns.co.uk.

US Information

Joerns Healthcare Ltd,
2100 Design Road, Suite 100
Arlington, TX 76014
USA

☎ : 800-826-0270
☎ : 800-457-8827
✉ : info@joerns.com
🌐 : www.joerns.com

Definitions Used in this Manual

WARNING:

Means: Failure to understand and follow these instructions may result in injury to yourself and others.

CAUTION:

Means: Failure to follow these instructions may cause damage to the product.

NOTE:

Means: This is important information regarding the correct use of the product.

Intended Use

The *Voyager Portable* is designed for lifting patients in a homecare setting, at nursing homes and other assisted living centres. Patient transfer must be done under the supervision of trained caregivers as per the instructions therein.

The product must only be used for the purposes stated above. It must be installed by Joerns Healthcare authorized personnel as per local codes.

Operational Life

The equipment is designed and tested to support at minimum, a useful life of seven (7) years or 10,000 transfers, whichever comes first. It is subject to preventive maintenance as specified in the "Care and Maintenance" section in this manual.

The expected life for consumable products such as batteries, fuses, straps and cords is dependent upon the care and usage of the product concerned. Consumables must be maintained in accordance with published Instructions for Use and the "Preventive Maintenance Schedule".

Product Identification

The lift's identification number (specification, model, serial number) appears on a silver nameplate affixed on the back of the casing.













How to Use this Manual



WARNING: Do not attempt to use this product without fully understanding the information contained in this manual. A misuse of this unit may lead to a patient fall and to injuries.

Keep this manual with the lift and refer to it as needed. Make sure that all operators are regularly trained in the use of the product as per the information found therein.





General Information

Symbols Used

General Symbols	Key to Symbols
	Points out the date of manufacture and the address of the manufacturer
	Product comply with the medical device directive 93/42/EEC.
	Approved by the Canadian Standards Association.
	Manufacturer's catalogue number.
	Manufacturer's serial number.
	Refers to the <i>Instructions for Use</i> .
	"Separate collection" for all batteries and accumulators as per the WEEE Directive.
	Risk of pinching.
SWL	SWL represents the maximum load the lifter is rated for safe operation.
IP_{N₁}N₂	Degree of protection provided by enclosure. N ₁ : Ingress of particles, N ₂ : Ingress of water.
	Direct current.
	Alternating current.
	Type BF applied part.
	Operating Temperature Range.

General Symbols	Key to Symbols
	Operating Humidity Range.
	Keep dry.

Charger Related Symbol	Key to Symbol
	Class II electrical equipment: term referring to electrical equipment in which protection against electric shock does not rely on basic insulation only.

Sling Related Symbols	Key to Symbols
	Maximum washing temperature: 80 °C (176 °F), permanent cycle.
	Do not use bleach.
	Do not dry clean.
	Tumble dry low temperature.
	Do not iron.

Safety Instructions

The product must be put in service and used as per these safety instructions.

Anyone using the product must also have read and understood this manual.

If there is anything you are not sure about, contact your local Joerns Healthcare agent.

General Instructions

Keep these safety instructions with the *Voyager Portable* lift at all times.

CAUTION: The *Voyager Portable* is for transferring patients only. Do not use the lift for any other purpose.

WARNING: Always place the sling around the patient as per the instructions enclosed. Failure to do so may result in injuries to you or to others.

CAUTION: Do not drop the lift, since it may cause internal damage that is not easily seen. If you suspect any damages to the lift, contact your local Joerns Healthcare agent for servicing.

NOTE: Joerns Healthcare lifts are designed for ArjoHuntleigh/Easytrack rail systems, Joerns Healthcare slings and accessories.

Safe Working Load

The *Voyager Portable* has been designed with a lifting capacity of 200 kg (440 lb).

WARNING: The *Voyager Portable* is intended to be used for patients whose weight is within a specified safe working load. Do not attempt to lift more than the lowest weight limit indicated on the following:

- the rail system;
- the “maximum load” label on the lift;
- on the accessories;
- on the sling.

Surcharge of any of these elements may lead to a patient fall and to injuries.

Safety Instructions

Important Safety Directions

Always ensure that:

- The lift is installed by an authorized Joerns Healthcare contractor or installer.
- The product is used by trained caregivers.

WARNING: Before attempting a transfer, a clinical assessment of the patient's suitability for transfer should be carried out by a qualified health professional. A transfer conducted when it should not can degrade the patient's health condition.

- Special consideration is taken when transferring a patient who is connected to electrodes, catheters or other medical devices.
- Violent impact during transfers is avoided.
- The sling is not damaged, torn or frayed and the straps are in good condition and properly fastened.
- The lifting steps found in this manual are followed.
- All controls and safety features are used only as per the rules specified in this manual. Never attempt to force a control or button on the lift.
- The charger is not stored in a shower, bath or other areas with high humidity.
- Any precautionary or instruction labels are read and those that cannot be easily read are replaced.
- The daily maintenance is carried out before using the lift.

WARNING: Joerns Healthcare warns of possible strangulation risks related to the lifting strap and hand control cable, and advises to take necessary precautions to prevent these.

WARNING: This product contains small parts (such as caps, see Fig. 6) that might present a severe danger to children if swallowed or inhaled.

CAUTION: Keep all components of the lift clean and dry.

CAUTION: Excessive exposure of the hand control to water (or other liquid) could cause malfunction of the device.

Shock Prevention

- Do not touch or use a lift with bare conductors or a damaged power cord. Electrically live equipment can result in serious injuries. If the lift or charger has any exposed or damaged wires, contact your local Joerns Healthcare agent immediately.
- Do not splash or expose the device to water or moisture.
- Check nameplate for input voltage and frequency requirements. These ones differ by country. Do not attempt to use the lift in an area that has a different voltage and frequency requirement.
- Read battery and charger instructions thoroughly before using or storing them.

Fire and Explosion Prevention

- Do not place or store the battery under direct sunlight or near a heat source.
- Do not expose the batteries to flames. They might open, causing a chemical leak.
- Do not use the charger in the presence of flammable anaesthetic gases. The charger might generate a spark, which could cause an implosion.
- Do not short circuit the battery terminals.

Safety Instructions

Human and Environmental Safety Practices

- Should the battery casing crack and cause contents to come in contact with skin or clothing, rinse immediately with plenty of water.
- If contents come in contact with the eyes, rinse immediately with plenty of water and seek medical attention.
- Inhalation of the contents can cause respiratory irritation. Provide fresh air and medical attention.
- For recycling and disposal of the batteries, the rules as per the WEEE directive (Waste of Electronic and Electrical Equipment) as well as local laws and regulations must be followed. If not they may explode, leak and cause personal injury. When returning batteries, insulate their terminals with adhesive tape. Otherwise, the residual electricity in used batteries may cause fire or explosion.

Battery and Battery Charger Safety Practices

WARNING: Following the instructions is important for the safe use of the battery.

Only use batteries designed for use with the device. If unsure, do not use the battery. Make sure it belongs to the device by comparing the battery label with the technical specifications in the *Instructions for Use*. If battery type cannot be confirmed, call your Joerns Healthcare agent.

- Do not expose the battery or chargers to flames.
- To avoid bodily injury, do not crush, puncture, open, dismantle or otherwise mechanically interfere with the battery.
- Stop using the battery if any damage or deformation is noted.
- Be careful not to drop the battery.
- Only use the charger that has been supplied with the product.
- Do not charge the battery in an unventilated area.
- The charger must not be covered or exposed to dust.
- The charger is designed for dry areas only and for normal air humidity conditions.

Homecare Environment Considerations

WARNING: Following the instructions is important for the safe use of the battery.

WARNING: The *Voyager Portable* is not intended to be operated by children. Serious injuries could occur.

NOTE: Rigorous cleaning actions should be done when the *Voyager Portable* is exposed to an animal. Pet hair trapped inside the device (through the strap opening) can reduce the product performance.

Parts Designation

Voyager Portable Lift and Charging Station

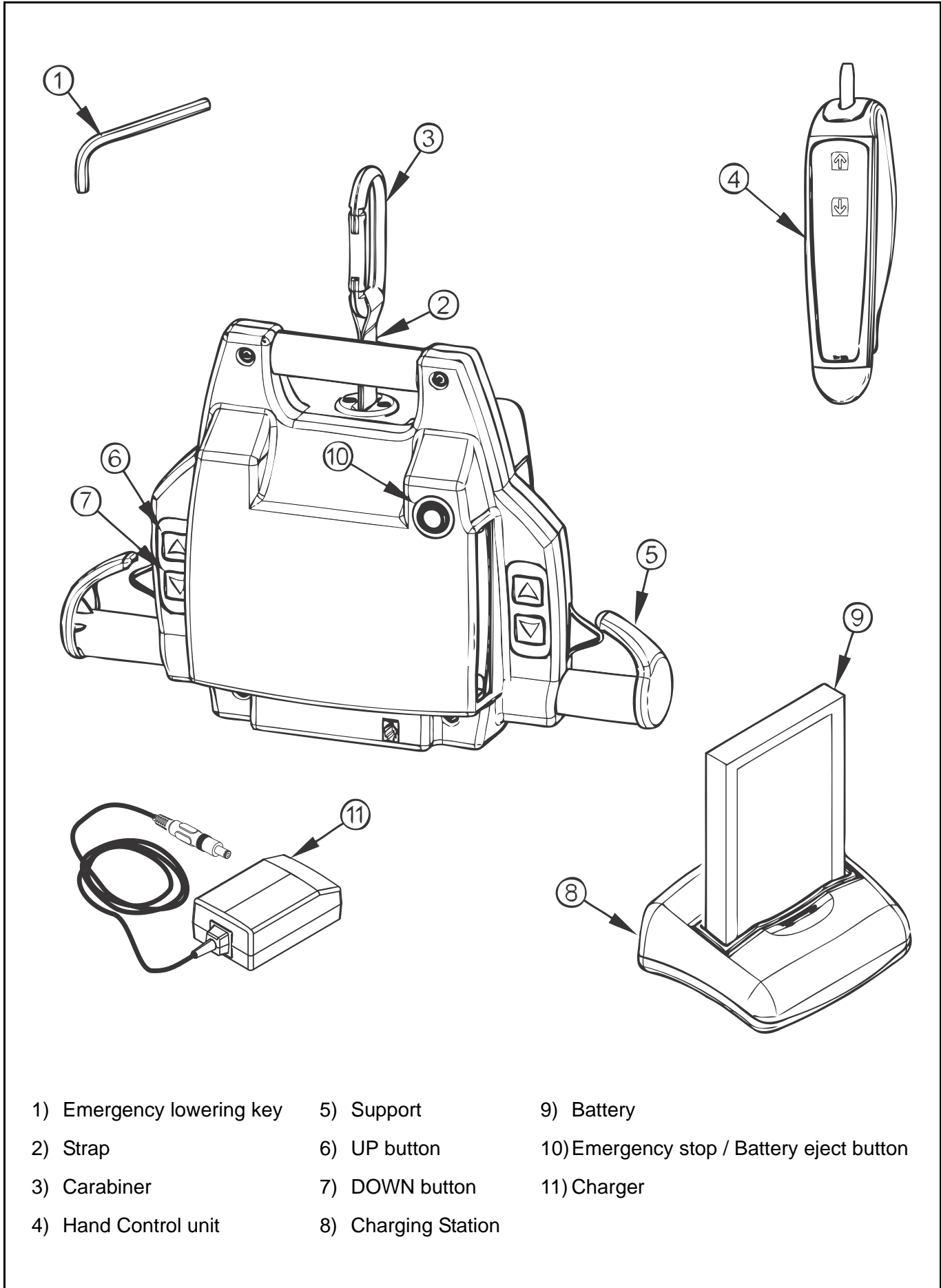

- | | | |
|---------------------------|---------------------|---|
| 1) Emergency lowering key | 5) Support | 9) Battery |
| 2) Strap | 6) UP button | 10) Emergency stop / Battery eject button |
| 3) Carabiner | 7) DOWN button | 11) Charger |
| 4) Hand Control unit | 8) Charging Station | |

Fig. 1

Hand Control

The *Voyager Portable*'s hand control is used to operate the lift. Each function is described in Fig. 2. The up and down buttons raise or lower the lift.

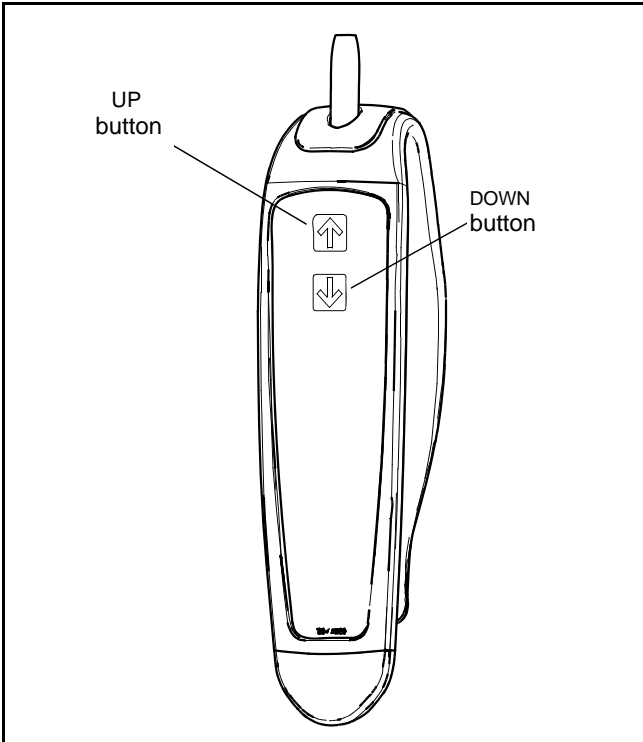

Fig. 2

How to Use the Voyager Portable

WARNING: All rails must be closed with end stoppers or connected to other closed rail components. Before use, make sure all end stoppers are in place and secured. A wrong installation of these items might lead to a patient fall and to injuries.

WARNING: The lift must never be operated by the patient. In the unlikely case of a failure, the patient might get stuck in the unit.

Before Approaching the Patient

Attendants should always tell the patient what they are about to do. Make sure to have on hand a sling that is of the correct model and of adequate size for transfer with the *Voyager Portable*.

Before performing the transfer, it is important to evaluate the patient's general condition. For example, an agitated patient will require a more specific type of sling.

Attachment Methods

Once the loop sling has been fitted around the patient, it can be configured in three ways. With each of the three methods described below, it is necessary to first connect each shoulder loop of the sling to both sides of the spreader bar.

Attachments Points

The attachment point designation shown here are only for the purpose of the explanations below.

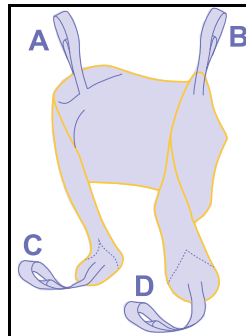

Fig. 3

Method 1 - Cross-through

(Legs closed with crossing straps)

This method is recommended for most general transfer.



Fig. 4

Method 2 - Hammock

(Bridge, legs closed)

This method can provide a comfortable cradle for amputee patient.

It is also a useful method for patients with contractures, making it difficult to bring a sling strap between the legs.



Fig. 5

WARNING: Method 2 might not be suitable for confused, combative or erratic patients as they can fall forward and get injured.

Method 3 - Abduction

(Legs opened with non-crossing straps)

In this method, legs are held in abduction which is convenient for toileting and hygiene care.



WARNING: Method 3 might not be suitable for patients with no upper body control as they can slide down and almost out of the sling.

How to Use the Voyager Portable

Transferring the Patient

- 1) Install the sling around the patient.
- 2) Take the battery out of the charger and insert it into the lift. Make sure the silver contact points go inside the lift.
- 3) Once the patient sling is installed, unwind the strap.

There are two ways to unwind the strap:

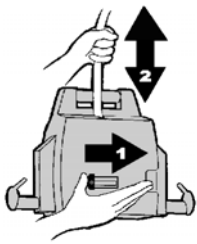

First, you can press the down button while holding tension on the strap with the other hand (there must be tension on the strap for the lift to function).

The other way is to use the "quick-release". (1) Push the knob sideways and (2) pull the strap out of the lift.

CAUTION: Push the knob completely over to ensure that the quick-release will work properly.

The quick-release will not work if there is tension on the strap. Make sure the strap has some slack in it before attempting to slide the knob over.

DO NOT force the knob. It should slide easily.

- 4) Attach the carabiner to the trolley in the rail.

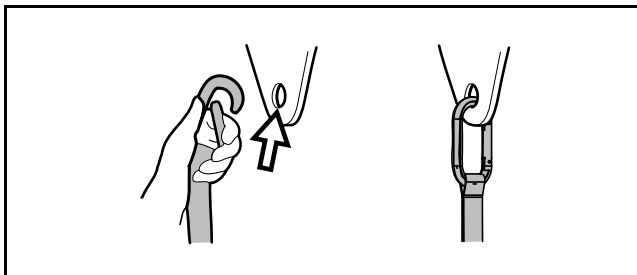
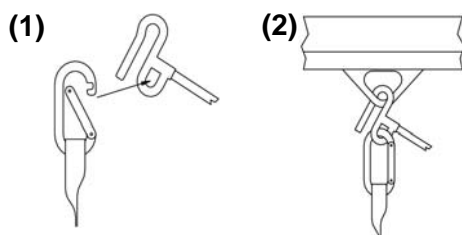

Fig. 6

- 5) Move the lift over to the patient.

Note: To help you reach the trolley, use the arm extension as follows:

Insert the round hook into the loop of the arm extension #A8300 (1), then hook it to the trolley in the track (2).



WARNING: Hold the lift with one hand at all times when near a patient. The proximity of the lift near the patient's face may cause the patient some discomfort.

- 6) Lower the lift to approximately below the patient's chin level before beginning to attach the sling straps (this is to avoid the unit from making contact with the patient's face due to the movement of the lift).

For a patient in a lying position, lower the lift near the thorax, and then install the straps.

- 7) Attach the straps of the sling as described in the sling's documentation.

WARNING: Before lifting the patient:

- 1) Make sure that all straps are attached to the lift's supports.
- 2) Make sure the patient's arms are safely out of the way.
- 3) Make sure the sling is not caught on any obstructions (wheelchair brake or arm of chair, etc.).

If any of the above occurs, lower the patient immediately and correct the problem.

- 8) Lift the patient slightly by pressing the UP control button.

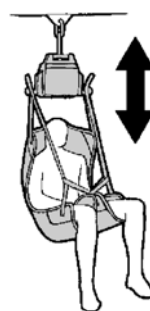

- 9) Lift until the patient's buttock clears all obstacles in the transfer path, chair arm supports for example, before moving the patient. Guide the legs past any obstacle.

- 10) When the patient is located above the desired point of transfer and ready to be lowered, press the down button.

WARNING: A patient should never be left unattended during a transfer. In the unlikely event of a failure of the device, the caregiver must be ready to react.

- 11) Use the handles on the back of the sling to position the patient when transferring into a chair. Hold the handles firmly as the sling lowers and the sling will tilt back to position the patient.

- 12) Once the patient is properly seated and the straps are loose, remove the sling from the lift.

How to Use the Voyager Portable

13) Slide the lift away from the patient.

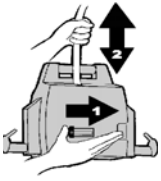

14) Unhook the lift from the trolley in the rail and use the “quick release” to wind up the strap. To do so, (1) push the knob sideways and (2) hold the strap while it winds itself into the lift.

CAUTION: When using the “quick-release”, hold the strap in your hand and release the knob only when the strap is not in motion. This will prevent wear of the internal components.

15) Remove the sling from around the patient.

Emergency Lowering

The *Voyager Portable* has a safety feature that allows the lift to be lowered even if the electrical system does not operate.

Located on the right side of the lift (near the sling support), the emergency lowering device is activated by the insertion of the special key included with this manual.

To lower safely a patient, follow these steps, as illustrated in Fig. 7:

- 1) Find the rubber stopper and label on the side of the lift and pull it out. Do not discard it.
- 2) Move the patient over a bed or chair.
- 3) Insert the 4 mm Allen key into the opening then turn it clockwise to lower the patient. The key rotation turns the motor directly, so that for each key turn, the patient will lower slightly.

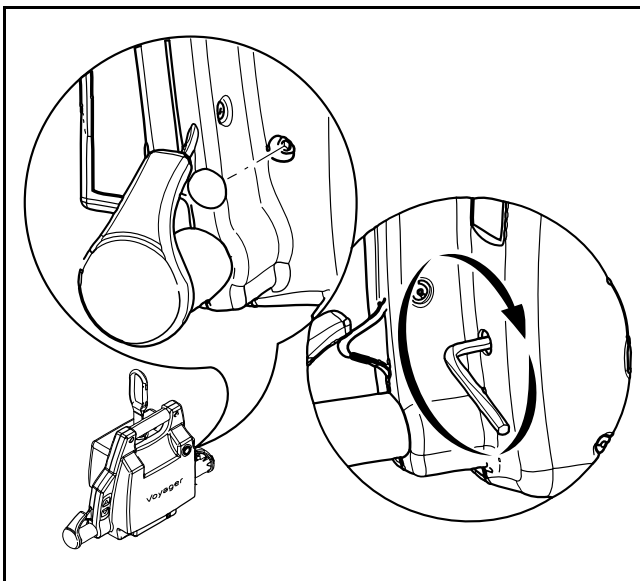

Fig. 7

CAUTION: The emergency lowering feature is to be used only in case of emergency.

- 4) Once the patient is lowered safely on a bed or into a wheelchair, remove the key from the lift and call a qualified technician to service your *Voyager Portable*.

Emergency Brake

The emergency brake is an additional safety feature that automatically prevents the patient from falling in the unlikely event of a transmission or motor failure.

WARNING: After an incident has occurred and the brake was deployed, never attempt to unlock the brake or press the UP button. This may disengage the brake and make the patient fall. The emergency lowering device cannot be used.

WARNING: Never use a lift with the emergency brake deployed. Use other product to lower the patient. The emergency brake is intended for a single activation and therefore can only be used once. Call your Joerns Healthcare agent Service Department to arrange for the unit to be replaced.

Battery Information

For safe handling and to extend the battery lifetime, please follow and remember these instructions.

CAUTION: Not following these instructions can cause short battery life.

Only use batteries designed and labelled for use with the device. When not sure, do not use the battery. Make sure the battery belongs to the device by comparing the battery label with the technical specifications in this manual. If battery type cannot be confirmed, call your Joerns Healthcare agent.

Battery life depends on many factors: frequency of use, frequency of charging, temperature of operation, storage and storage time.

Make sure to have a replacement battery ready when needed. Have the facility department keep one in stock.

The battery included in the *Voyager Portable* is 24 VDC, 2.0 Ah and rechargeable. It provides 10 to 30 transfers per battery charge.

How to Use the Voyager Portable

NOTE: To prolong battery life, place the battery in the charger whenever the lift is not in use. If the low battery indicator beeps, be sure to recharge the battery as soon as possible. Charge the battery until the charging indicator light is a solid yellow before using the lift again. This will extend the life of the battery.

NOTE: Joerns Healthcare uses sealed lead-acid batteries. These batteries are not affected by any memory effect. Therefore, batteries should not be completely drained before recharging.

Charging the Battery

WARNING: Do not operate the charger with a damaged cord or if the unit has been dropped or damaged. Do not bend the power cord by force, or place a heavy object on it. This will damage the cord and may cause fire or electrical shock.

CAUTION: Only use chargers that are specified by Joerns Healthcare to recharge the batteries.

The steps for recharging the battery are as follows:

- 1) Eject the battery from the lift unit by pressing on the battery eject button.

NOTE: To avoid dropping the battery, keep your hand near the battery opening when pressing on the battery eject button.

- 2) Check to make sure that the green light on the charger is illuminated. Insert the battery into the charger, ensuring that the metal contact points on the battery touch the charger's contacts.

The charging indicator light (yellow) will flash while the battery is charging. When the battery is fully charged, the charging indicator light will become solid.

If the battery is low, it will take approximately two hours for a full charge.

If the battery is fully drained it could take up to 6 hours to recharge.

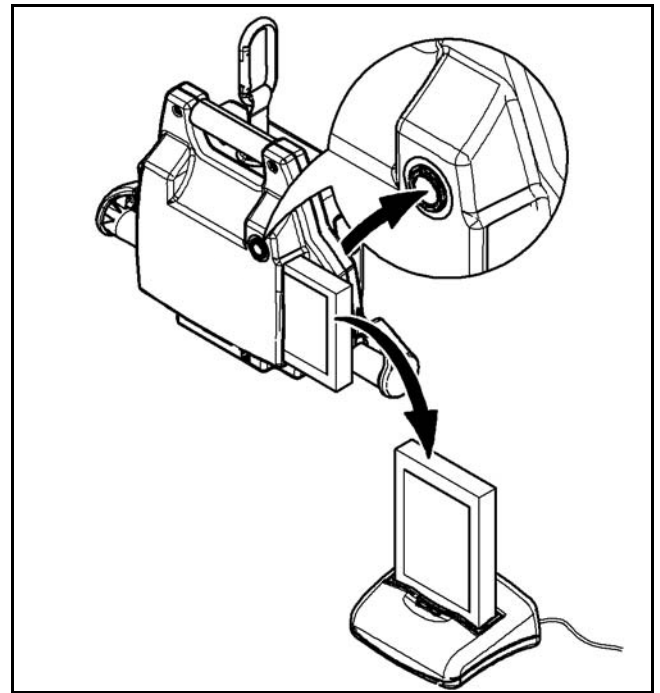

Fig. 8

NOTE: Whenever possible, leave the battery in the charger when the lift is not in use.

At a minimum, charge the battery until the charging light turns solid yellow before using again. This will extend the life of the battery.

When the lift is needed again, pull the battery out of the charger and gently slide it back into the *Voyager Portable* lift. The metal contacts should be inside the lift.

The charger's power cord can remain plugged into the wall indefinitely, convenient for overnight recharging.

The battery can be left in the charger for an extended period of time without damaging either the charger or the battery.

If the green light does not go on when the charger is plugged into an electrical outlet, see the "Troubleshooting" section.

CAUTION: Do not attempt to use a battery not authorized by the manufacturer. The *Voyager Portable* and its charging system use specially designed batteries. Using unauthorized batteries may seriously damage the lift or the charger.

CAUTION: The lift should not remain stored for long period of time without charging the battery. Batteries should be recharged at least every two weeks to maximize their life-span.

Care and Maintenance

Preventive Maintenance Schedule

The product is subjected to wear and tear, and the following maintenance instructions must be acted upon when specified to ensure that it remains within its original manufacturing specifications. Care and maintenance must be carried out as per the preventive maintenance schedule below.

Customer obligations must be carried out by qualified personnel as per the instructions in this manual.

WARNING: The maintenance described in the following checklist is the minimum that the manufacturer recommends. In some cases more frequent inspections should be carried out. Continuing to use this product without conducting regular inspections or when a fault is found will seriously compromise the safety of the user and of the patient. Local regulations and standards may be higher than those of the manufacturer. A load test is recommended. Service and preventive maintenance can be arranged with the manufacturer. Preventive maintenance specified in this manual can prevent accidents and reduce repair costs.

WARNING: Safety related maintenance and authorized service must be carried out by qualified personnel, fully trained in servicing procedures by Joerns Healthcare, and equipped with correct tools and proper documentation, including Parts List and Service Manual. Failure to meet these requirements could result in personal injuries and/or unsafe product.

User Inspections

Action/Check	INITIALLY	BEFORE EVERY USE	EVERY 2 MONTHS	EVERY 4 MONTHS	EVERY YEAR	EVERY 2 YEARS
Lift device						
INSPECT FOR MISSING HARDWARE OR BROKEN ENCLOSURE.	X	X			X	
INSPECT STRAP FOR WEAR.		X	X			
RECHARGING BATTERY.		X				
INSPECT THE SLING SUPPORTS ON THE LIFT FOR DAMAGE OR CRACKS.					X	
INSPECT WHEELS IN RAIL FOR DAMAGE, RUST OR CRACKS. REPLACE IF DAMAGED.					X	
CLEAN THE RAIL.				X		
OVERALL INSPECTION BY AUTHORIZED PERSONNEL.					X	
INSPECT CARABINER FOR DAMAGE OR CRACKS					X	
VERIFY EMERGENCY STOP BUTTON.				X		
VERIFY EMERGENCY LOWERING DEVICE.				X		

Care and Maintenance

Action/Check	INITIALLY	BEFORE EVERY USE	EVERY 2 MONTHS	EVERY 4 MONTHS	EVERY YEAR	EVERY 2 YEARS
Slings and hardware						
CHECK ALL SLING ATTACHMENTS FOR SIGN OF WEAR.		X				
INSPECT SLING MATERIAL FOR WEAR OR DETERIORATION.		X				
INSPECT SLING STRAPS FOR WEAR.		X				
INSPECT FOR ANY DEFECTS OR LOOSE THREADS IN THE "STITCHED AREAS".		X				
CLEANING SLING AS INDICATED ON THE TAG.	WHEN NECESSARY					

Inspections by an Authorized Service Technician

Action/Check	INITIALLY	BEFORE EVERY USE	EVERY 2 MONTHS	EVERY 4 MONTHS	EVERY YEAR	EVERY 2 YEARS
Authorized Service						
Replace strap.						X
Inspect the welding aspect on the frame to detect cracks.					X	
Inspect transmission.					X	
Inspect connecting joints for proper attachment.					X	
Verify that the emergency brake on the drum is turning freely.					X	
Verify emergency devices for good functioning.					X	
Load test with SWL (maximum working capacity).					X	

NOTE: If the product does not work as intended, immediately contact your local Joerns Healthcare agent for support.

WARNING: Always reinstall the rail end stoppers (if removed) after servicing.

WARNING: Make sure the trolley is compatible with the stoppers and rail system.

Care and Maintenance

Cleaning the Lift

NOTE: It is recommended to clean the lift and its accessories between each patient use.

Removing visible residues:

- 1) Use a cloth soaked with water.
- 2) Remove visible residues from the lift and its accessories (sling, handset, strap) from top to bottom.

Cleaning:

- 1) To clean the *Voyager Portable* and its accessories, spray cleaning fluid on the product, and use a brush (to remove any deposits).
- 2) Use a clean damp cloth with clear water to wipe off all spots of cleaning fluids.
- 3) If cleaning fluid cannot be removed on some hard-to-access parts, spray water on the affected part and wipe off with disposable towels/cloth. Repeat until all of the cleaning fluid has been removed.
- 4) Repeat steps 1 to 3 as necessary.
- 5) Let the parts dry.

NOTE: Pay special attention to areas pointed in. These are most likely to enclose germs. Use a smaller brush and/or cotton swab to reach them.

CAUTION: Do not drench the product, as this could damage electrical components and cause internal corrosion.

If a hot air dryer is used to dry the lift, the temperature must not exceed 80°C (176 °F).

Do not use petroleum-based solvents, as this may damage plastic parts.

Voyager Portable's Special Areas to Clean

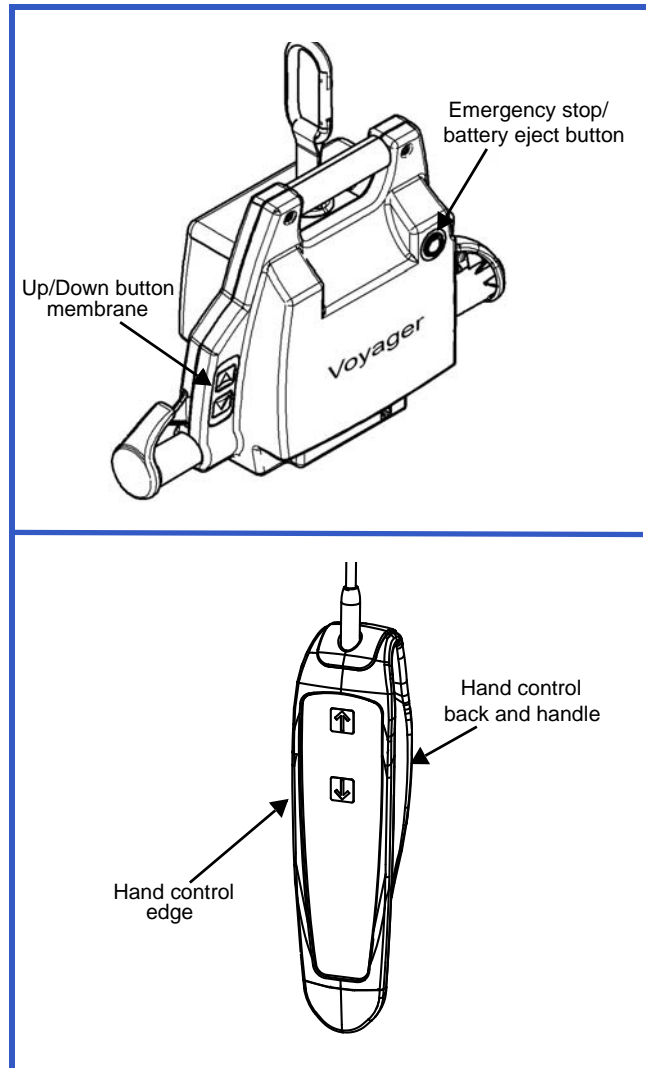

Fig. 9

To ensure a better rolling surface for the trolley wheels, clean the inside of the rail every 4 months. To do so, insert a damp cloth in the opening and slide it from one end of the rail to the other.

Care and Maintenance

Daily Checklist

The following procedures must be followed before each use:

- Charge the battery.
- Inspect the lift for any damage. If the lift casing does not look properly aligned, or there are any cracks or other damage on the lift, or there are parts missing, do not use it. Contact your Joerns Healthcare agent to have the lift serviced.
- Inspect the strap for any visible signs of wear, frays, loose threads or other damage (see Fig. 10). If there is any evidence of damage, do not use it. Contact your local Joerns Healthcare agent to have the lift serviced.
- Inspect the sling for tears, frayed straps or loose stitching. If the sling has any of the above damage, do not use it. Contact your local Joerns Healthcare agent to have the sling replaced or repaired.
- Inspect the carabiner at the top of the strap to ensure that it is properly attached.

WARNING: Before each use, make sure all end stoppers on the rail are in place and secured.

NOTE: The lift cassette and the sling should be cleaned between use of different patients.

WARNING: Do not splash, drench or immerse the unit in water.

Strap Inspection

If the strap is damaged or shows signs of wear or discoloration, the acceptable load on the strap before rupture can drop rapidly and present a danger for the patient or caregiver. Joerns Healthcare recommends a thorough inspection of the straps every two months as follows:

- 1) Completely unwind the strap.
- 2) Look for any signs of wear or discoloration (see Fig. 10).

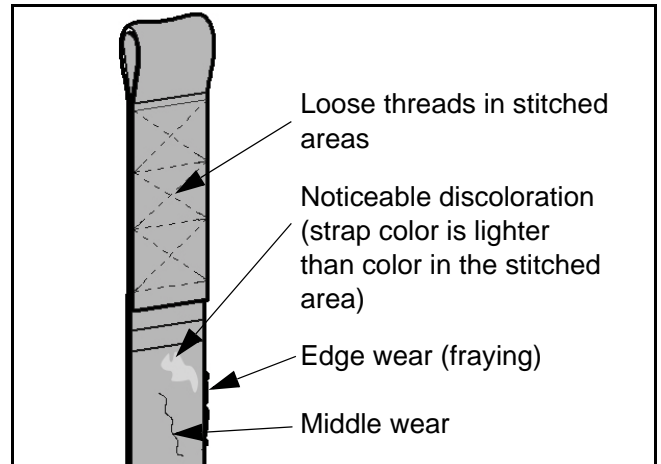

Fig. 10

WARNING: The strap must be changed if it shows any sign of wear as indicated above or any other visual defects.

The manufacturer recommends changing the strap at least every 2 years or every 2850 cycles—which ever comes first.

By continuing to use the lift without changing a damaged strap, the safety of the caregiver or patient is greatly compromised.

Handling and Storage

Avoid violent impacts while transporting the lift.

The lift should not remain stored for long periods of time without recharging the battery.

NOTE: Even if the lift is not used, Joerns Healthcare recommends charging the battery at least every two weeks. This will prevent premature aging of battery.

If you store or ship the *Voyager Portable*, ensure that the power is turned off (push the battery eject button) beforehand.

Battery Replacement

Replace the battery when there is a noticeable reduction in the number of transfers that can be performed between charges. If you hear the *Voyager Portable* lift beeping, see the instructions in the “Troubleshooting” section of this manual to determine if there is a problem with the battery.

For battery replacement, contact your local Joerns Healthcare agent.

CAUTION: Do not attempt to use a battery that was not supplied by Joerns Healthcare. The battery has been specially designed for Joerns Healthcare charging systems. Attempting to use an unauthorized battery may seriously damage the lift and/or the charger.

Care and Maintenance

Verification of the Charger's Power Source

If the light does not illuminate when the battery is correctly installed in the *Voyager Portable* charger, try the following:

- 1) Make sure that the charger is correctly plugged into the AC outlet, and that the green light is on.
- 2) Make sure that the battery is properly inserted in the charger.
- 3) Check the power of the AC outlet on the wall.
- 4) If the charger's yellow or green light does not light up, contact your local Joerns Healthcare agent for assistance.

Sling Inspection and Care

Refer to documentation included with slings.

WARNING: The slings should be checked before and after use and, if necessary, washed as per instructions on the sling. This is especially important when using the same equipment for another patient. This minimizes the risk of cross infection.

Annual Inspection

The *Voyager Portable* and its accessories must be inspected annually by a qualified technician.

WARNING: The *Voyager Portable* and accessories must be serviced every 12 months as a minimum requirement. Do not attempt to do the inspection unless you are qualified to do so. Not servicing the product may lead to patient fall, causing injuries.

UK Regulation

Note: In the UK the *Voyager Portable* must be inspected and maintained in compliance with 1998 no 2307 health & safety: lifting operations and lifting equipment regulations 1998. Your dealer will provide you with more information.

Troubleshooting

PROBLEM	VERIFY
The unit does not work when you press the UP or DOWN buttons on the hand control.	<ul style="list-style-type: none"> • Make sure the hand control is plugged correctly into the unit. • Use the control switches directly on the unit. If they are working, it indicates a problem with the hand control; you would then need to change the hand control.
The unit does not work when you press the UP or DOWN buttons on both sides of the lift.	<ul style="list-style-type: none"> • Is the battery charged and correctly installed? Ensure the battery is inserted into the lift with the metal contact points inside the lift. Place the battery into the charger and check the light on the charger. If the yellow light keeps flashing, leave the battery in the charger for approximately 2 hours. • Is the “quick release” knob completely to the left (locked) position? If not, the lift will not operate. Tighten the tension on the strap to help move the “quick release” knob. • Is there tension on the strap? The “anti-crush” feature will prevent the lift from working if there is no tension. <p>If all of the previous points have been checked without success, you probably have a motor or electrical problem. You need to call your Joerns Healthcare agent.</p>
The unit starts and stops repetitively.	<ul style="list-style-type: none"> • If the load is more than safe working load, the unit will not work due to an overload protection on the motor. • Has the lift been making a “beeping” sound? The battery is low and needs to be charged.
The unit emits a “beep” during use. The unit may stop lifting but you can still lower it.	<ul style="list-style-type: none"> • Battery is low. Recharge it.
Battery is always dead after only a few transfers (3 to 5).	<ul style="list-style-type: none"> • Replace battery with a new one, the life of the current one is probably nearly over. (See “Battery Information” in the “Care and Maintenance” section).
The light on the charger shows a solid yellow when the battery is inserted, yet the lift will only do one or two transfers.	<ul style="list-style-type: none"> • Battery has either been dropped or damaged in some other way. Replace the battery.
The charger’s green light is not illuminated.	<ul style="list-style-type: none"> • Is the charger plugged into a standard outlet? Try plugging the charger into another outlet to see if it will work. • If the green light will still not illuminate, contact your local agent.

Troubleshooting

PROBLEM	VERIFY
When battery is inserted into the charger, the yellow light does not flash or illuminate solid.	<ul style="list-style-type: none"> • Check the orientation of the battery. The contact points should be inside the charger. • If the yellow charge light will still not illuminate, contact your local agent.
The battery does not slide into the lift.	<ul style="list-style-type: none"> • Check if there is any damage to the battery that would interfere in the lift battery's slot. IF THERE IS DAMAGE - DO NOT USE THE BATTERY. • Try to slide in another battery to see if there is any damage in the lift battery's slot. If so, call your Joerns Healthcare agent. If not, discard the damaged battery.
Cannot remove battery from the lift.	<ul style="list-style-type: none"> • See "How to Use the <i>Voyager Portable</i>" section, under "Charging the Battery" on how to correctly remove the battery. • If the battery will not come out of the lift, tilt the lift to the side so that the battery opening is under the lift. With your hand guarding the opening for the battery, press the eject button on the front of the <i>Voyager Portable</i> while gently tapping the lift to help jolt the battery out of the lift. ONCE THE BATTERY IS REMOVED – DISCARD BATTERY AND REPLACE. • If you cannot remove the battery after trying the above, contact your local agent for assistance.

Labels on the Lift

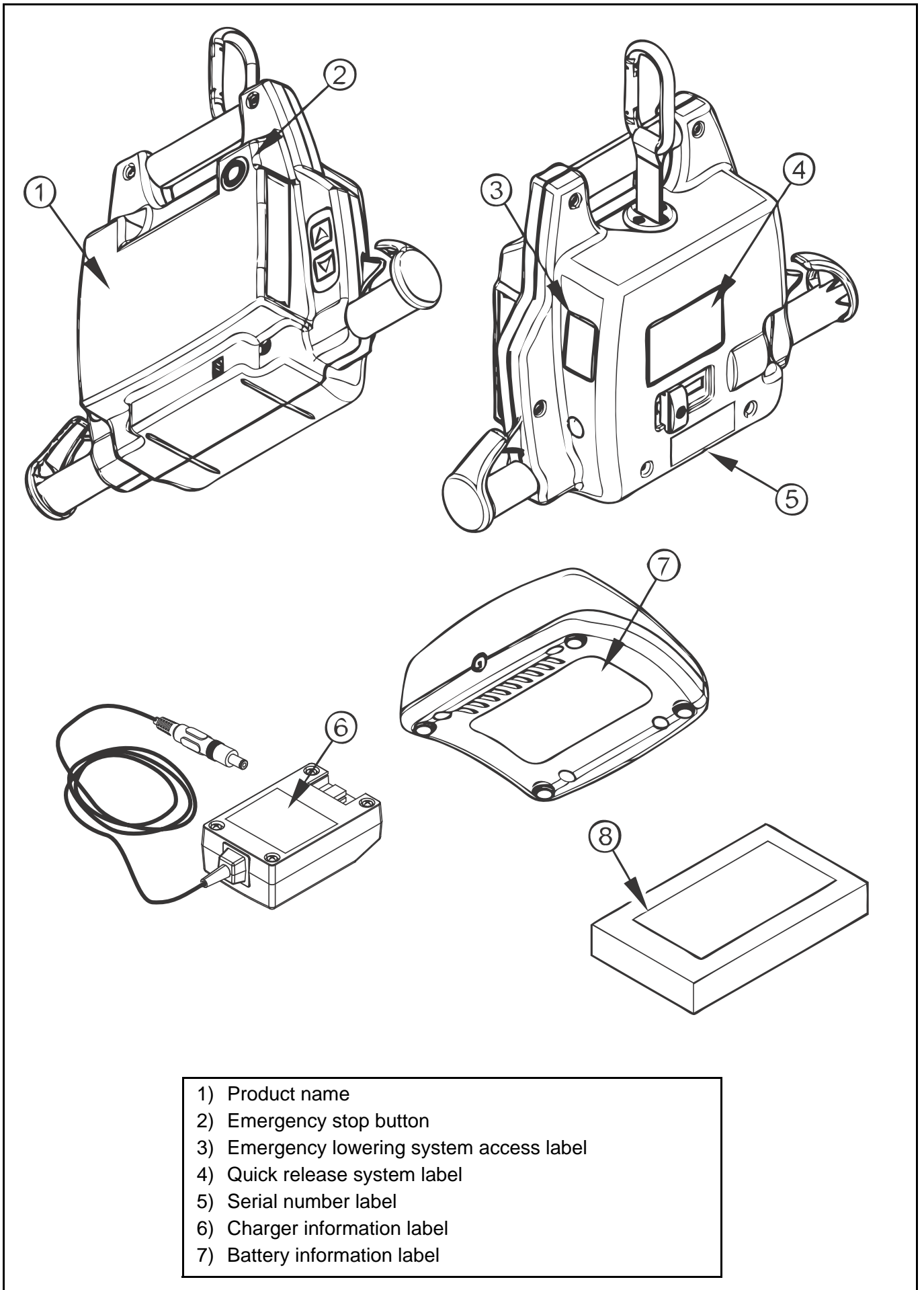

Fig. 11

Technical Specifications

PRODUCT INFORMATION	
Weight, complete	5.45 kg (12 lb)
Lifting capacity	200 kg (440 lb)
Strap length	2200 mm (88 in)
Lifting speed	4.3 cm/s (1.7 in/s)
Operating force of control	< 5 N
ELECTRICAL	
Duty cycle	Max 10%, 6 min/hr, (max. 1 min. continuous)
Rating	24 VDC, 10 A max.
Noise level for either raising or lowering, with or without load	70 dBA max.
Medical equipment	Type BF protection against electrical shock as per IEC 60601-1
The <i>Voyager Portable</i> is compliant with CAN/CSA C22.2 No. 601.1 (SUP1+AM2), UL 60601 1, CAN/CSA-C22.2 No. 60601-1-08, ANSI/AAMI ES60601-1:2005, and tested as per ISO 10535.	
WARNING: Wireless communications equipment such as wireless home network devices, mobile phones, cordless telephones and their base stations, walkie-talkies, etc. can affect the <i>Voyager Portable</i> and should be kept at least 2.3 m away from it. Cables from potentially strong sources of electromagnetic fields should not be placed near the unit.	
BATTERY AND CHARGER UNIT	
Battery	Qty: 1 x rechargeable 24 VDC, 2.0 Ah
Battery capacity	Provides up to 30 transfers with a load of 80 kg (176 lb)
Degree of protection - Hand Control	IPX7
Degree of protection - <i>Voyager Portable</i>	IPX0 - Keep dry
Lift - protection class - shock prevention	Internally powered equipment
Battery Charger input	100-240 VAC, 50-60 Hz, 50 VA
Battery Charger output	24 VDC, 1 A, 24 VA
Battery Charger safety protection	Class 2, double insulated
OPERATION CONDITIONS	
Ambient temperature range	+5 °C to +40 °C (+41 °F to +104 °F)
Relative humidity range	15% to 93%, non-condensing
Atmospheric pressure range	700 hPa to 1060 hPa (max. 2000 m)
STORAGE CONDITIONS	
Ambient temperature range	-25 °C to +70 °C (-13 °F to +158 °F)
Relative humidity range	< 94%, non-condensing
Atmospheric pressure range	500 hPa to 1060 hPa
WARNING: This product is not suitable in the presence of flammable anaesthetic mixtures with air or oxygen, or with nitrous oxide. Using the <i>Voyager Portable</i> in this environment might lead to an explosion. The lift might create some spark internally and ignite the gas.	
RECYCLING	
Battery	Sealed lead-acid, rechargeable, recyclable
Package	Cardboard recyclable
The lift	Separated and recycled, as per the European Directive 2002/96/EG (WEEE).

Technical Specifications

Lift Dimensions

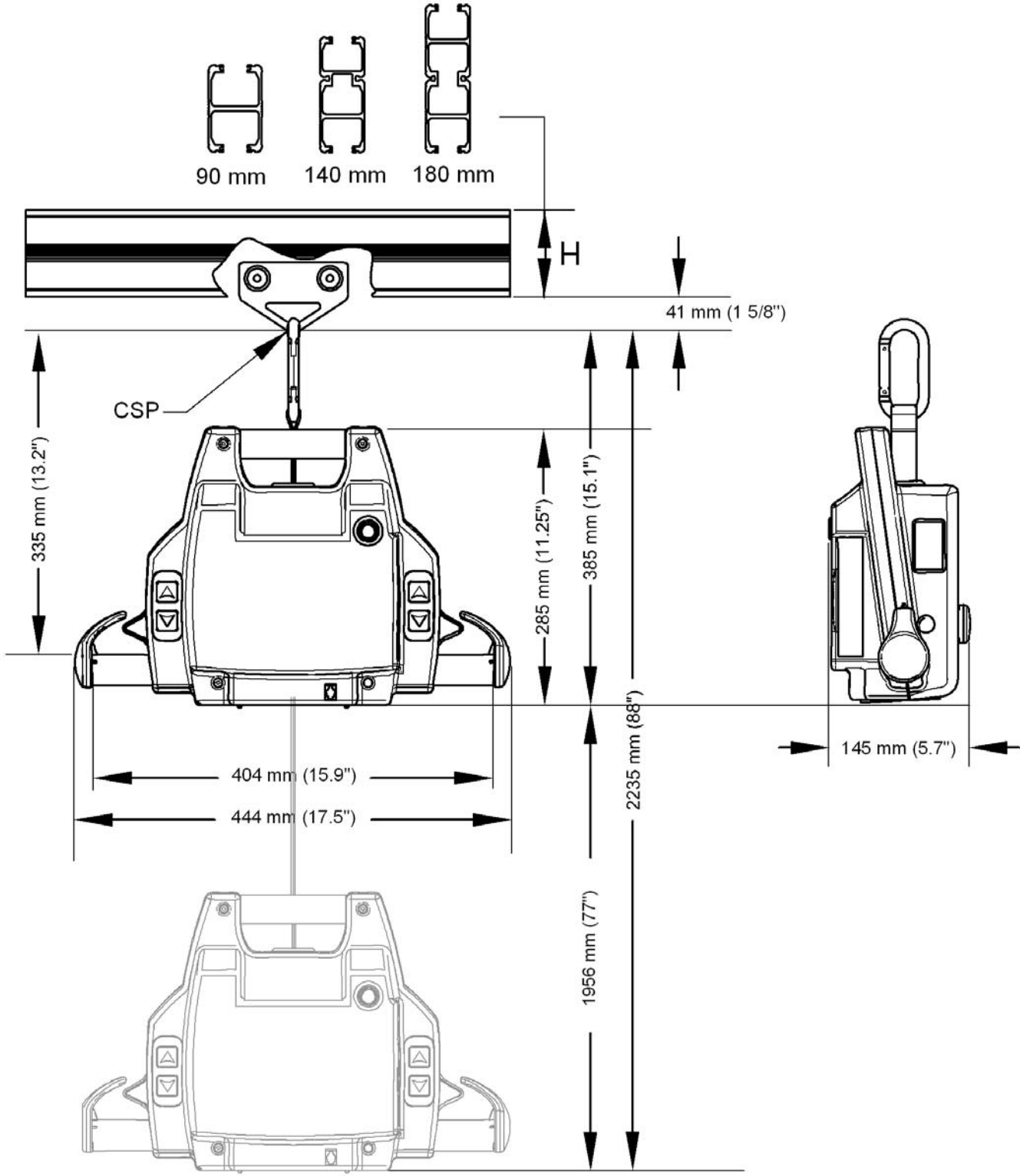

Fig. 12

Electromagnetic Compatibility

Electromagnetic Compliance

The *Voyager Portable* has been tested for compliance with current regulatory standards regarding its capacity to block EMI (electromagnetic interference) from external sources.

Nonetheless, some procedures can help reduce electromagnetic interferences:

- Use only Joerns Healthcare cables and spare parts to avoid increased emissions or decreased immunity which can compromise the correct functioning of the equipment.
- Ensure that other devices in patient-monitoring and/or life-support areas comply to accepted emissions standards.
- Maximize the distance between electro-medical devices. High-powered devices may produce EMI that can affect the ceiling lift. Refer to separation distance table further on in this document.

For more information on how to manage the unit's RF electromagnetic environment, please consult the *AMI TIR 18-1997 - Guidance on Electromagnetic Compatibility of Medical Devices for Clinical/Biomedical Engineers*.

Electromagnetic Emissions

Guidance and Manufacturer's Declaration - Electromagnetic Emissions - For all Equipment and Systems		
The <i>Voyager Portable</i> is intended for use in the electromagnetic environment indicated below. The customer or the user of the <i>Voyager Portable</i> should assure that it is used in such an environment.		
Emissions test	Compliance	Electromagnetic environment - guidance
RF emissions CISPR 11	Group 1	The <i>Voyager Portable</i> uses RF energy only for its internal function. Therefore, its RF emissions are very low and are not likely to cause any interference in nearby electronic equipment.
RF emissions CISPR 11	Class B	The <i>Voyager Portable</i> is suitable for use in all establishments, including domestic establishments and those directly connected to the public low-voltage power supply network that supplies buildings used for domestic purposes.
Harmonic emissions IEC 61000-3-2	Not applicable	
Voltage fluctuations/flicker emissions IEC 61000-3-3	Not applicable	

Electromagnetic Compatibility

Electromagnetic Immunity

Guidance and Manufacturer's Declaration - Electromagnetic Immunity - For all Equipment and Systems			
The <i>Voyager Portable</i> is intended for use in electromagnetic environment specified below. The customer or the user of the <i>Voyager Portable</i> should assure that it is used in such an environment.			
Immunity test	IEC 60601 test level	Compliance level	Electromagnetic environment - Guidance
Electrostatic discharge (ESD) IEC 61000-4-2	±6 kV contact ±8 kV air	±6 kV contact ±8 kV air	Floors should be wood, concrete or ceramic tile. If floors are covered with synthetic material, the relative humidity should be at least 30%.
Electrical fast transient/burst IEC 61000-4-4	±2 kV for power supply lines ±1 kV for input/output lines	Not applicable ±1 kV for input/output lines	Mains power quality should be that of a typical commercial or hospital environment.
Surge IEC 61000-4-5	±1 kV differential mode ±2 kV for input/output	Not applicable	Mains power quality should be that of a typical commercial or hospital environment.
Voltage dips, short interruptions and voltage variations on power supply input lines IEC 61000-4-11	<5% <i>UT</i> (>95% dip in <i>UT</i>) for 0.5 cycle 40% <i>UT</i> (60% dip in <i>UT</i>) for 5 cycles 70% <i>UT</i> (30% dip in <i>UT</i>) for 25 cycles <5% <i>UT</i> (>95% dip in <i>UT</i>) for 5 sec.	Not applicable	Mains power quality should be that of a typical commercial or hospital environment.
Power frequency (50/60 Hz) magnetic field IEC 61000-4-8	3 A/m	3 A/m	Power frequency magnetic fields should be at levels characteristic of a typical location in a typical commercial or hospital environment.
NOTE: <i>UT</i> is the AC mains voltage prior to application of the test level.			

Electromagnetic Compatibility

(continued)

Guidance and Manufacturer's Declaration - Electromagnetic Immunity - For Equipment and Systems that are Not Life-Supporting			
Immunity test	IEC 60601 test level	Compliance level	Electromagnetic environment - guidance
Conducted RF IEC 61000-4-6	3 Vrms 150 kHz to 80 Mhz	3 Vrms 150 kHz to 80 Mhz	<p>Portable and mobile RF communications equipment should be used no closer to any part of the <i>Voyager Portable</i>, including cables, than the recommended separation distance calculated from the equation applicable to the frequency of the transmitter.</p> <p>Recommended separation distance</p> $d = \left[\frac{3,5}{V1} \right] \sqrt{P}$ <p style="text-align: right;">150 KHz to 80 MHz 150 KHz to 80 MHz</p> $d = \left[\frac{3,5}{E1} \right] \sqrt{P}$ <p style="text-align: right;">80 MHz to 800 MHz</p> $d = \left[\frac{7}{E1} \right] \sqrt{P}$ <p style="text-align: right;">800 MHz to 2.5 GHz</p>
Radiated RF IEC 61000-4-3	3 V/m 80 MHz to 2.5 GHz	10 V/m 80 MHz to 2.5 GHz	<p>where P is the maximum output power rating of the transmitter in watts (W) according to the transmitter manufacturer and d is the recommended separation distance in meters.</p> <p>Field strengths from fixed RF transmitters, as determined by an electromagnetic site survey, ^(a) should be less than the compliance level in each frequency range. ^(b)</p> <p>Interference may occur in the vicinity of equipment marked with the following symbol:</p> 
NOTE 1: At 80 MHz and 800 MHz, the higher frequency range applies.			
NOTE 2: These guidelines may not apply in all situations. Electromagnetic propagation is affected by absorption and reflection from structures, objects and people.			
(a) Field strengths from fixed transmitters, such as base stations for radio (cellular/cordless) telephones and land mobile radios, amateur radio, AM and FM radio broadcast and TV broadcast cannot be predicted theoretically with accuracy. To assess the electromagnetic environment due to fixed RF transmitters, an electromagnetic site survey should be considered. If the measured field strength in the location in which the <i>Voyager Portable</i> is used exceeds the applicable RF compliance level above, the <i>Voyager Portable</i> should be observed to verify normal operation. If abnormal performance is observed, additional measures may be necessary, such as reorienting or relocating the <i>Voyager Portable</i> .			
(b) Over the frequency range 150 kHz to 80 MHz, field strengths should be less than 3 V/m.			

Electromagnetic Compatibility

(continued)

Recommended Separation Distance Between - Portable and Mobile RF Communications Equipment and the <i>Voyager Portable</i> for Equipment and Systems that are not Life-Supporting			
Recommended separation distances between portable and mobile RF communications equipment and the <i>Voyager Portable</i> .			
The <i>Voyager Portable</i> is intended for use in an electromagnetic environment in which radiated RF disturbances are controlled. The customer or the user of the <i>Voyager Portable</i> can help prevent electromagnetic interference by maintaining a minimum distance between portable and mobile RF communication equipment (transmitters) and the <i>Voyager Portable</i> as recommended below, according to the maximum output power of the communications equipment.			
Rated maximum output power of transmitter W	Separation distances according to frequency of transmitter m		
	150 kHz to 80 MHz	80 MHz to 800 MHz	800 MHz to 2.5 GHz
	$d = \left[\frac{3,5}{3} \right] \sqrt{P}$	$d = \left[\frac{3,5}{10} \right] \sqrt{P}$	$d = \left[\frac{7}{10} \right] \sqrt{P}$
0.01	0.12	0.12	0.24
0.1	0.37	0.37	0.74
1	1.17	1.17	2.34
10	3.69	3.69	7.38
100	11.67	11.67	23.34
For transmitters rated at a maximum output power not listed above, the recommended separation distance d in metres (m) can be estimated using the equation applicable to the frequency of the transmitter, where P is the maximum output power rating of the transmitter in watts (W) according to the transmitter manufacturer.			
NOTE 1: At 80 MHz and 800 MHz, the separation distance for the higher frequency range applies.			
NOTE 2: These guidelines may not apply in all situations. Electromagnetic propagation is affected by absorption and reflection from structures, objects and people.			



ArjoHuntleigh AB
Hans Michelsengatan 10
211 20 Malmö
SWEDEN